

Panel Brackets / Panel Mounting Screws

Steel, Stainless Steel

Panel Brackets Steel, Stainless Steel

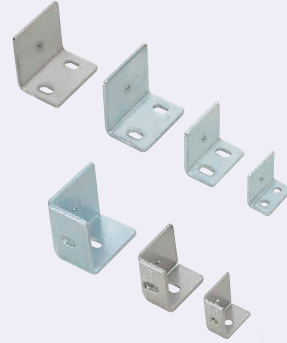

Type	Material	Surface Treatment
Steel Type	EN 1.0330 Equiv.	Bright Chromate Plating
Stainless Steel Type	EN 1.4301 Equiv.	-

For Middle Mounting

Steel Type **HCBV5**
Stainless Steel Type **SHCBV5**

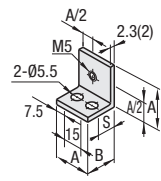

Steel Type **HCBV6**
HCBV8
HCBV8-45
Stainless Steel Type **SHCBV6**
SHCBV8
SHCBV8-45

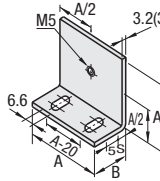

For Corner Mounting

Steel Type **HCBCV5**
Stainless Steel Type **SHCBCV5**

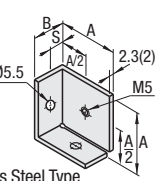

Steel Type **HCBCV6**
HCBCV8
HCBCV8-45
Stainless Steel Type **SHCBCV6**
SHCBCV8
SHCBCV8-45

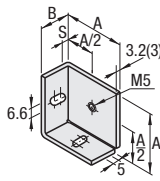

The values in () are for Stainless Steel Type.
So as to enhance reinforcement, the plate attachment hole height A/2 differs from that of Aluminum Type and Plastic Type.



Two methods of panel mounting are available for No. 6, 8 and 8-45 of Steel Type and Stainless Type (5mm thick or less) since these products have slotted holes.

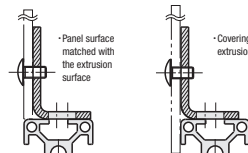

Steel Type

Part Number	Mass	Difference between the Extrusion Side and Attachment Face	S	A	B	Screw, Nut		HCBV		HCBCV	
						Screw	Nut	Unit Price	Volume Discount Rate	Unit Price	Volume Discount Rate
HCBV5	29	23	0	10	30	18	CBM5-8	HNTT5-5			
HCBV6	79	60	0-5 (Variable)	15	40	25	CBM6-12	HNTT6-6	2		
HCBV8	124	94	(Variable)	17.5	50	35	CBM6-15	HNTT8-6			
8-45											

Stainless Steel Type

Part Number	Mass	Difference between the Extrusion Side and Attachment Face	S	A	B	Screw, Nut		SHCBV		SHCBCV	
						Screw	Nut	Unit Price	Volume Discount Rate	Unit Price	Volume Discount Rate
SHCBV5	23	18.5	0	10	30	18	SCB5-6	HNTTSN5-5			
SHCBV6	62.5	50	0-5 (Variable)	15	40	25	SCB6-10	HNTTSN6-6	2		
SHCBV8	113	85.5	(Variable)	17.5	50	35	SCB6-15	HNTTSN8-6			
8-45											

Ordering Example
Part Number - Length
HCBV6 - **1000**
SHCBCV8 - **1000**

Alterations
Part Number - (SET)
HCBV6 - **SET**

Alteration	Code	Spec.	Bracket	Screw, Nut			
				For Extrusion Fitting		For Panel Fitting	
				Screw	Nut	Screw	Nut
Applicable Screw and Nut Set	SET	Applicable screws and nuts come in a set. When SET is specified, the product is not RoHS compliant.	HCBV5	CBM5-8	HNTT5-5		
			HCBV6	CBM6-12	HNTT6-6		HCBM5-10 (Below)
			HCBV8	CBM6-15	HNTT8-6		
			SHCBCV5	SCB5-6	HNTTSN5-5	2	
			SHCBCV6	SCB6-10	HNTTSN6-6		SHCBM5-10 (Below)
			SHCBCV8	SCB6-15	HNTTSN8-6		
			SHCBCV5	SCB5-6	HNTTSN5-5	2	
			SHCBCV6	SCB6-10	HNTTSN6-6		SHCBM5-10 (Below)
			SHCBCV8	SCB6-15	HNTTSN8-6		
			SHCBCV5	SCB5-6	HNTTSN5-5	2	
SHCBCV6	SCB6-10	HNTTSN6-6		SHCBM5-10 (Below)			

Panel Mounting Screws



Part Numbers shaded are not RoHS compliant.

HCBM
SHCBM (Stainless Steel)
HCBMB (Trivalent Chromate, Black)

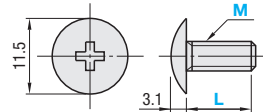

Type	Material	Surface Treatment
HCBM	Carbon Steel for Mechanical Structure	Bright Chromate Plating
SHCBM	EN 1.4301 Equiv.	-
HCBMB	Carbon Steel for Mechanical Structure	Trivalent Chromate (Black)

Part Number	Length	HCBM		SHCBM		HCBMB	
		Unit Price	Volume Discount Rate	Unit Price	Volume Discount Rate	Unit Price	Volume Discount Rate
HCBM	10	1-79 pc(s)	80-99	1-79 pc(s)	80-99	1-79 pc(s)	80-99
SHCBM	12						
HCBMB	15						

L Dimension 15 is for HCBM. For other screws, see P751.

For HCBM, SHCBM and HCBMB, package sales (500 pieces per package) are available for each size.

M-L	HCBM	SHCBM	HCBMB
5-10	Set of 500 pcs. (SET1)	Set of 500 pcs. (SET1)	Set of 500 pcs. (SET1)
5-12			
5-15			

When ordering, please note the quantity. 500 pcs. will be delivered for HCBM5-10-SET1 order.

Ordering Example
Part Number - L
HCBM5 - **10**

Part Number - L - SET1
HCBM5 - **10** - **SET1** (500 pcs.)

Slide Rails / Slide Spacers

Plastic Type

Slide Rails



HRLFLJ2
(For 2 Rows of 5mm Thick Plate)

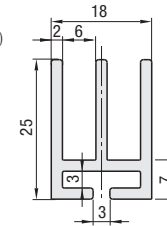

HRLFLJ3
(For 3 Rows of 5mm Thick Plate)

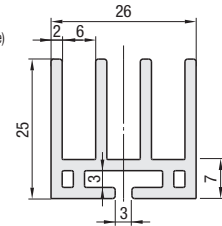

Use the Slide Rail Connectors to connect the Slide Rail to Aluminum Extrusions.

Material: ABS Resin (Light Gray)

Part Number	Length	Extrusion (Series)	Mass kg/m	Unit Price/m
HRLFLJ	50-2000	HFS5	0.185	
		HFS6	0.277	
		HFS8(-45)		

Slide Rail Connectors



HRLCN5

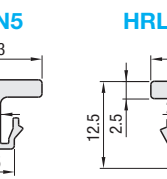

HRLCN6

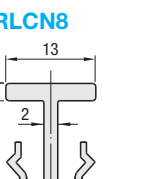

HRLCN8

Used to connect the Slide Rails to the Aluminum Extrusions.

Material: Polypropylene (Light Gray)

Part Number	Length	Extrusion (Series)	Mass kg/m	Unit Price/m
HRLCN	50-2000	HFS5	0.045	
		HFS6	0.064	
		HFS8(-45)	0.072	

Ordering Example
Part Number - Length
HRLFLJ3 - **1000**
HRLCN6 - **1000**



Connection with Extrusion

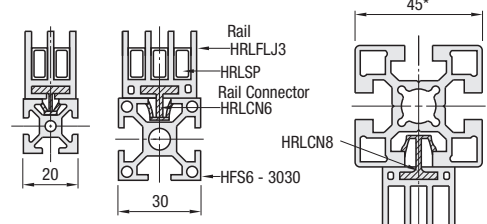

*Also use HRLCN8 for HFS8-50 and HFS8-60.

Select HRLFLJ3 and HRLCN6 in order to attach 3-rows rail to the frames of HFS6 Series.

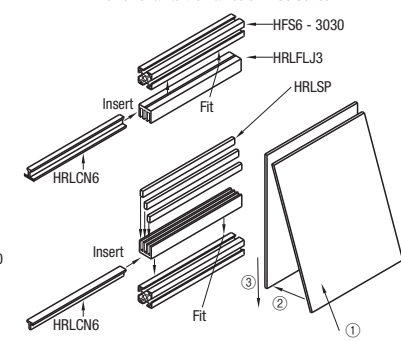

Post-assembly Side View

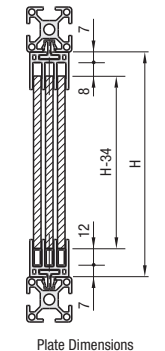
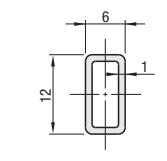

Plate Dimensions

Slide Spacers



HRLSP



Type	Material	Heat Resistance Temperature
HRLSP	Polyethylene (Black)	-45 ~ 80°C

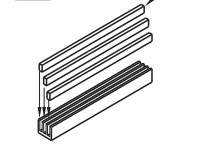

To be inserted into the lower rows of Slide Rails
Can be cut with scissors or a utility knife.

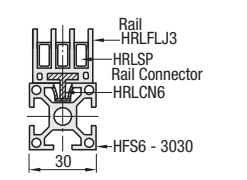

Part Number	Length mm	Unit Price	Volume Discount Rate	Part Number	Length mm	Unit Price (Set of 30 pcs.)
HRLSP	2000	1 ~ 9 pc(s)	10-50	HRLSP-SET	2000	

Ordering Example
Part Number
HRLSP
HRLSP-SET